

Note that all unique customer requirements (i.e tolerance) need to be verified thru Alfa Laval.

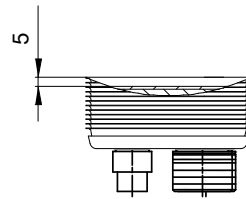
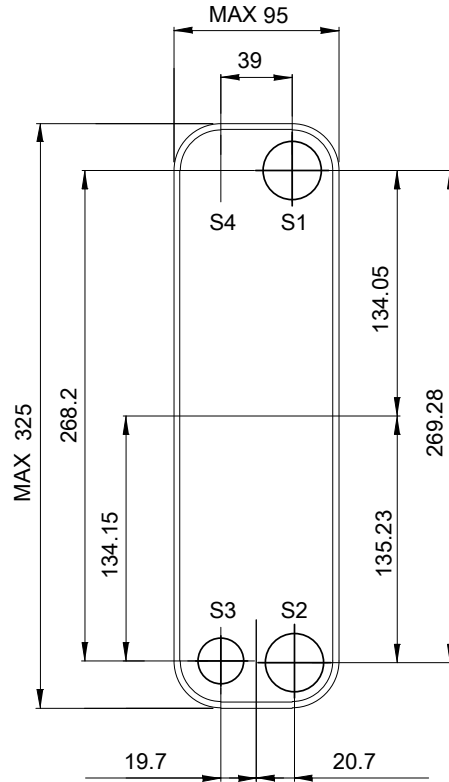
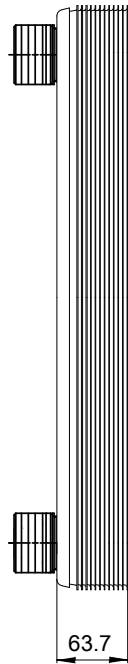
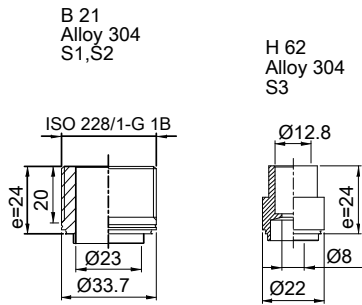

Frameplate is depressed 1.2 mm at connection S4  
 Pressureplate is depressed 1.2 mm / even number of channel  
 plates at connections T4 / uneven number of channel plates at  
 connections T1.  
 T1 T2 T3 T4 locations on back side  
 correspond to S1 S2 S3 S4 on front side

HEATING SURFACE  
 NETWEIGHT 4.56 kg  
 OPERATING WEIGHT  
 PLATE MATERIAL Alloy 316  
 PLATE GROUPING 1\*17H/1\*18H

ALL DIMENSIONS IN MILLIMETERS

SIDE	MEDIA	INLET	TEMP.	OUTLET	TEMP.	FLOW RATE	PRESSURE DROP	LIQUID VOL.
1								0.48 dm <sup>3</sup>
2								0.5 dm <sup>3</sup>

PRESSURE VESSEL APPROVAL PED

AC-30EQ-36H (3288101017)

www.alfalaval.com

CUSTOMER NAME / REF. NO.

TOTAL LENGTH 87.7 mm  
 TOTAL WIDTH 95.0 mm  
 TOTAL HEIGHT 325.0 mm

COMPANY / REF.

8/24/2017  
 REV 0