

This document and its contents is owned by Alfa Laval AB (publ) or its affiliates and protected by laws governing intellectual property and thereto related rights. Without limiting any rights related to this document, no part of this document may be copied, reproduced or transmitted in any form or by any means (electronic, mechanical, photocopying, recording, or otherwise), or for any purpose than expressed permission of Alfa Laval. Nor may it be used in any other way of for any other purpose than expressly permitted by Alfa Laval. Alfa Laval will enforce its rights related to this document to the fullest extent of the law, including the seeking of criminal prosecution.

Pharma-line S Double Tube Sheet Shell & Tube Heat Exchanger

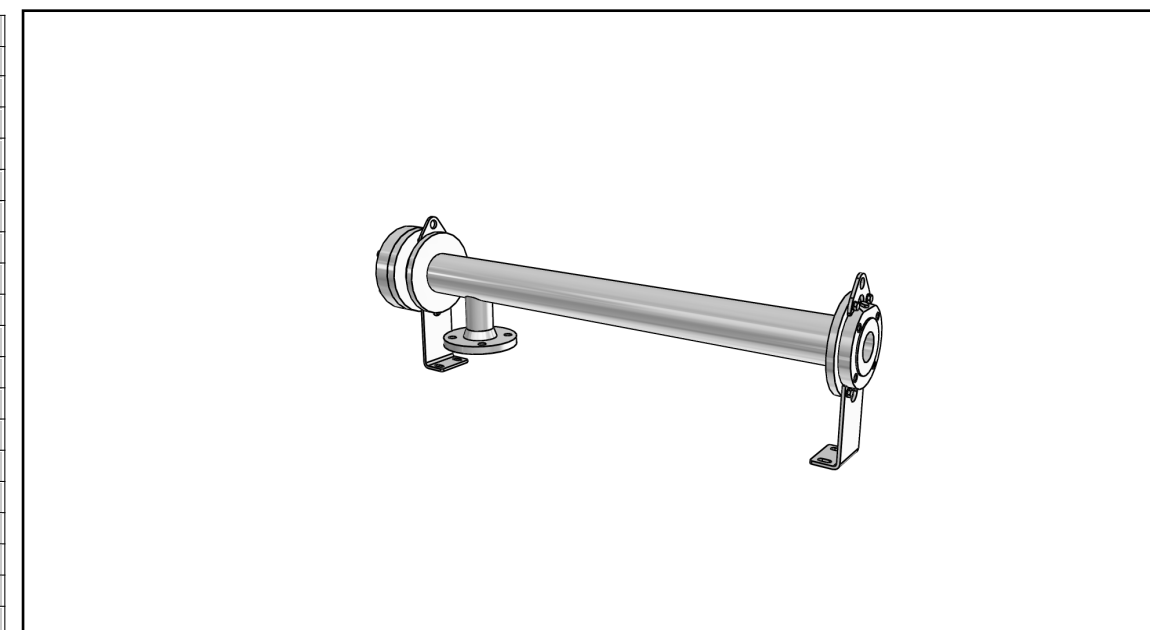
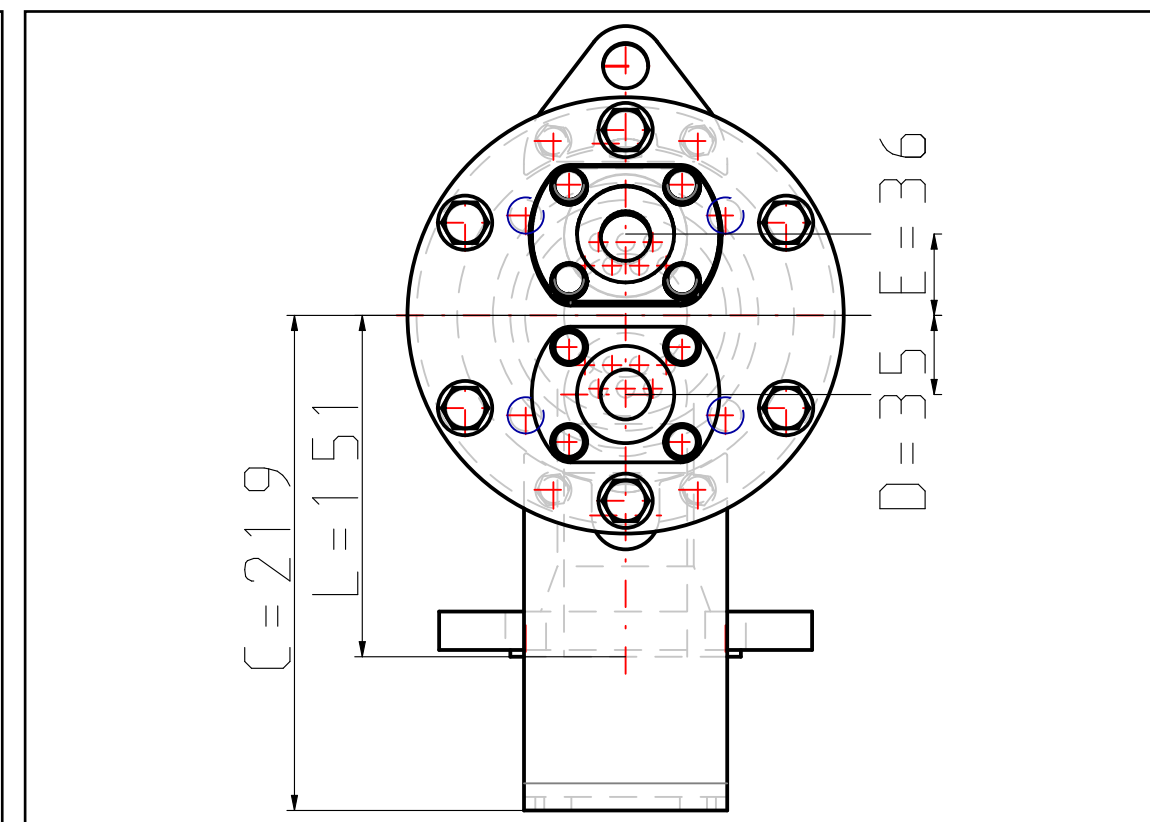
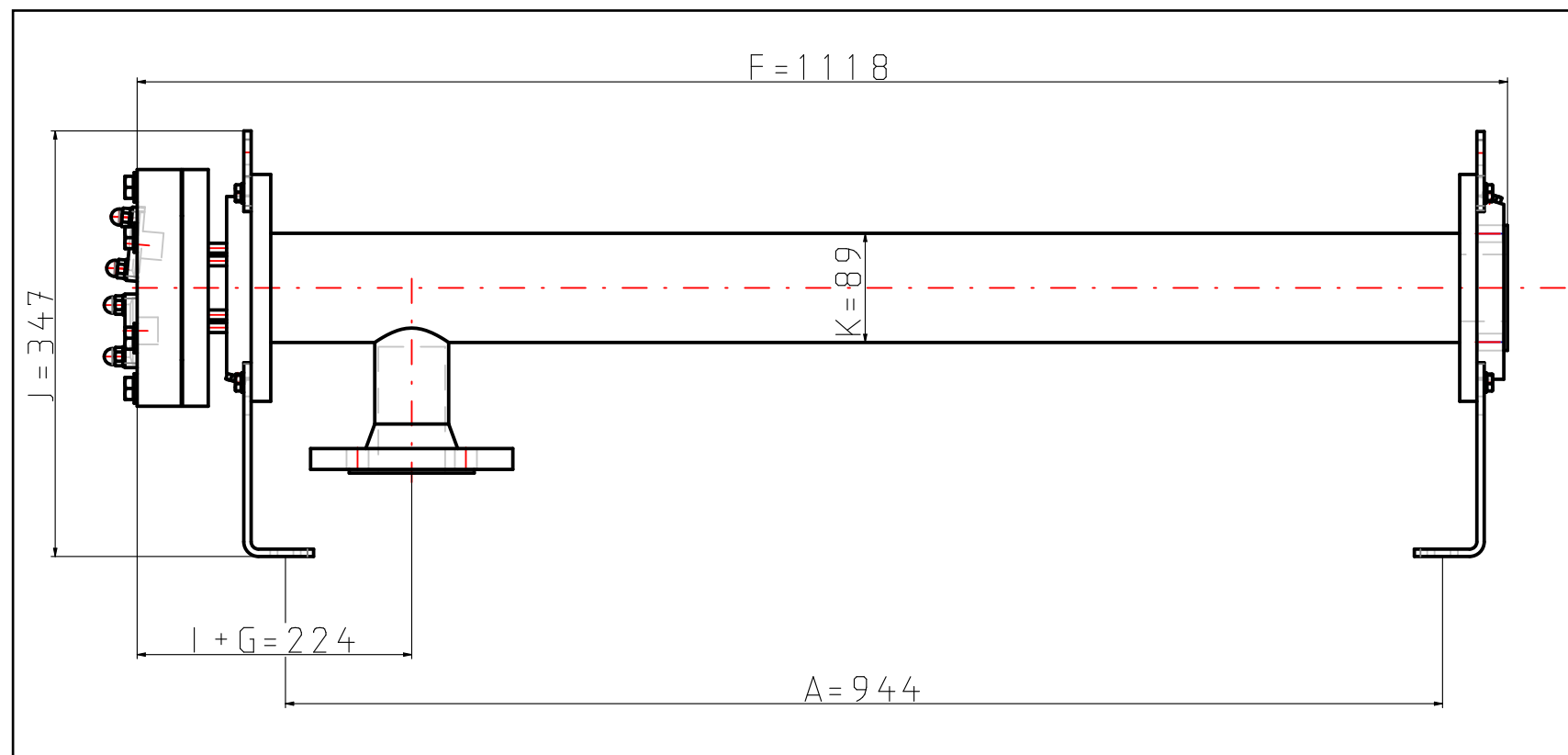

Item No	9615012504
Model name	Pharma-line S 1-0.3
Product connection size	NAC plate for Tri-clamp ASME BPE 1"
Shell connection size	Flange DN50
Item description	Pharma-line S 1-0.3 0,5MP PED
Extra description	IN ASME BPE1" DIN2635DN50DN50
Volume shell side	4.6 l
Volume tube side	0.6 l
Weight empty	35 kg
Nozzles size Tube	ASME/OD 1"
Nozzle size flange	DIN2635/EN1092 DN 50
A (Distance)	944 mm
B (Diameter)	193 mm
C (Height)	219 mm
D (Distance)	35 mm
E (Distance)	36 mm
F (Length)	1118 mm
G (Distance)	121 mm
I (Distance)	103 mm
J (Height)	347 mm
L (Height)	151 mm
K (Diameter)	89 mm
Pressure vessel code	PED (directive 97/23/EC)
Design pressure / Shell side	-1/10 bar (g)
Design temperature / Shell side	-10/150 °C
Material / Shell side	SS 304/304L
Material / Media side (tube)	SS316L
Connection standard & size / Shell side	Flange: DIN2635/EN1092-1
Connection standard & size / Media side (tube)	NAC plate for Tri-clamp
Surface finish	Ra < 0,5µm MP on product wetted parts
Insulation	-

Qty	Pos	Item No	Description	Material	Weight (kg)
		A3	12/07/2016 06:45		
		MM	AL CAD Portal		
9615012504					
1 OF 1					

Only to the extent expressly agreed by us this document may constitute a contractual obligation on our part

Revision No	-	Appr.	-
Checked	-	Checked	-
Revised	-	Revised	-
Date	-	Date	-
Revision	-	Revision	-
Replaces drawing No	-	Replaces drawing No	-
Rev No	-	Rev No	-