

PLACA PRESION
(MOVIBLE)
SECTION A-A

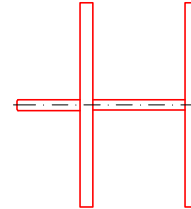

PLACA DE BASTIDOR

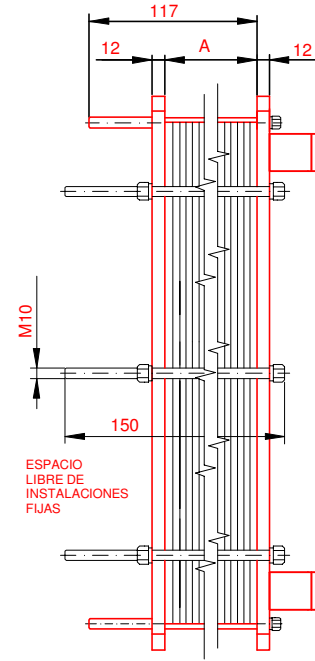
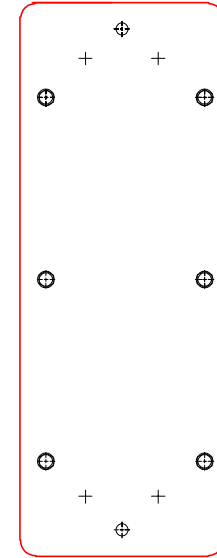
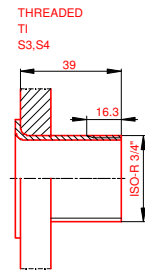
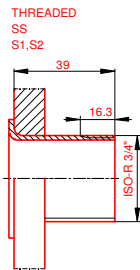
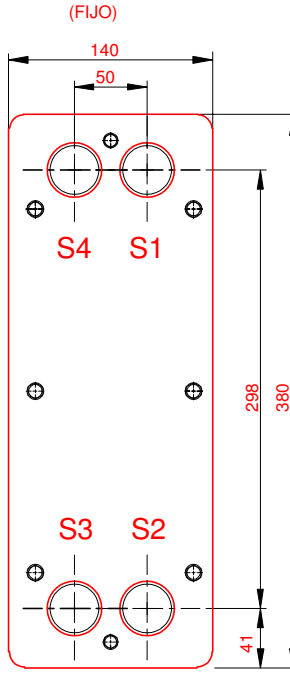

NOTAS:
 LADO 1 LADO 2
 PRESION PRUEBA 6,5 bar 6,5 bar
 PRESIÓN DISEÑO 5 bar 5 bar
 TEMP. MAXIMA 50 °C 35 °C
 TEMP. MIN. 0 °C 0 °C

JUNTA NBRP Clip-on
 MAT. DE PLACAS TI
 ESPESOR PLACAS 0,50 mm

PESO CON AGUA 17 kg
 CAPACIDAD CALORIFICA 15 kW

DIMENSIONES EN MILÍMETROS

Do not use this drawing for foundation bolting or piping layout.

LARGO 165
 ANCHO 140
 ALTO 380

LADO	FLUIDO	F.D.G.	ENTRADA	TEMP.	SALIDA	TEMP.	CAUDAL	PERDIDA-CARGA
1	Water		S1	50.0 °C	S2	40.0 °C	1.3 m³/h	46.55 kPa
2	Water		S3	15.0 °C	S4	32.0 °C	0.8 m³/h	18.00 kPa

ORDEN INTERNA	CANERIA	DIBUJO
		15KW
AGENTE / REF.		
CLIENTE / REF.		
REALIZADO	CAT. RIESGO	N/A

INTERCAMBIADOR DE CALOR DE PLACAS
T2-BFG
 ALS



PISCI Bomba 50-40°C HVAC
 FECHA 2016-09-28
 REV. Nº 0