

Note that all unique customer requirements (i.e tolerance) need to be verified thru Alfa Laval.

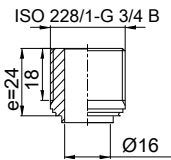

A 21
Alloy 316
S1,S2,S3,S4

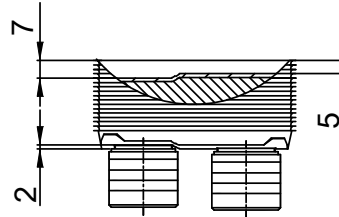
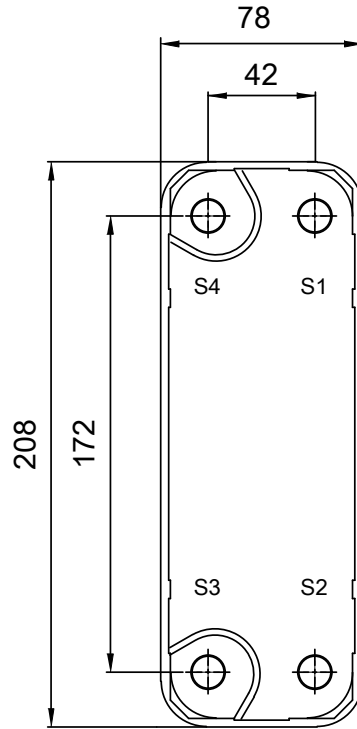
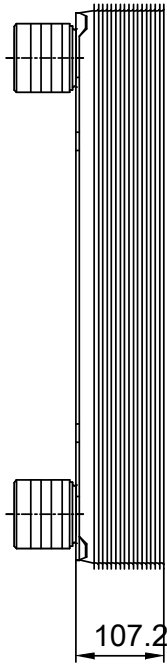

Frameplate is depressed 2 mm at connection S3/S4
Pressureplate is depressed 2 mm / even number of channel plates
at connections T3/T4 / uneven number of channel plates at
connections T1/T2.

T1 T2 T3 T4 locations on back side
correspond to S1 S2 S3 S4 on front side

HEATING SURFACE
NETWEIGHT 3.40 kg
OPERATING WEIGHT
PLATE MATERIAL Alloy 316
PLATE GROUPING 1*19H/1*20H

ALL DIMENSIONS IN MILLIMETERS

SIDE	MEDIA	INLET	TEMP.	OUTLET	TEMP.	FLOW RATE	PRESSURE DROP	LIQUID VOL.
1								0.38 dm ³
2								0.4 dm ³

PRESSURE VESSEL APPROVAL PED

AlfaNova 14-40H(A21,A21) (3287050664)

www.alfalaval.com

CUSTOMER NAME / REF. NO.

COMPANY / REF.

TOTAL LENGTH 131.2 mm
TOTAL WIDTH 77.0 mm
TOTAL HEIGHT 207.0 mm

8/24/2017
REV 0