

Note that all unique customer requirements (i.e tolerance) need to be verified thru Alfa Laval.

CPF80FP
ALLOY 316
S1,S2,S3,S4

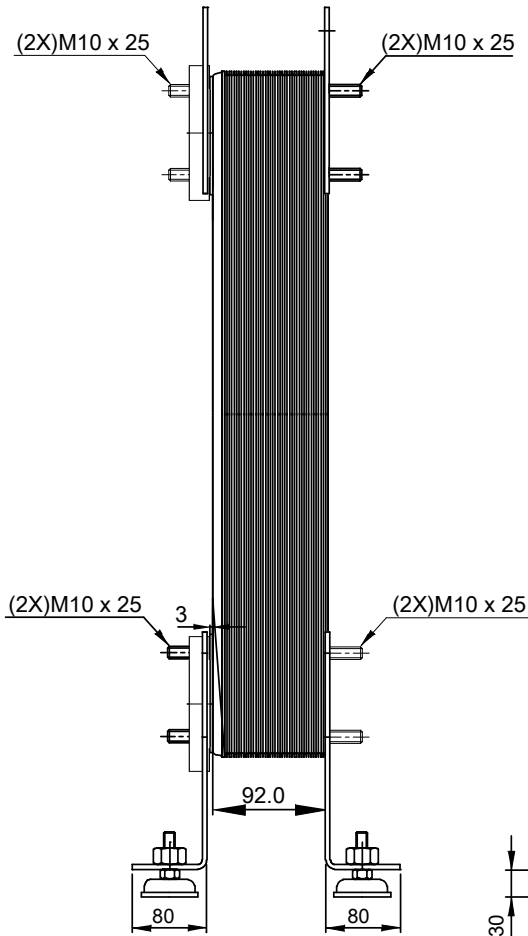

FRAME PLATE

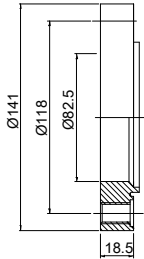
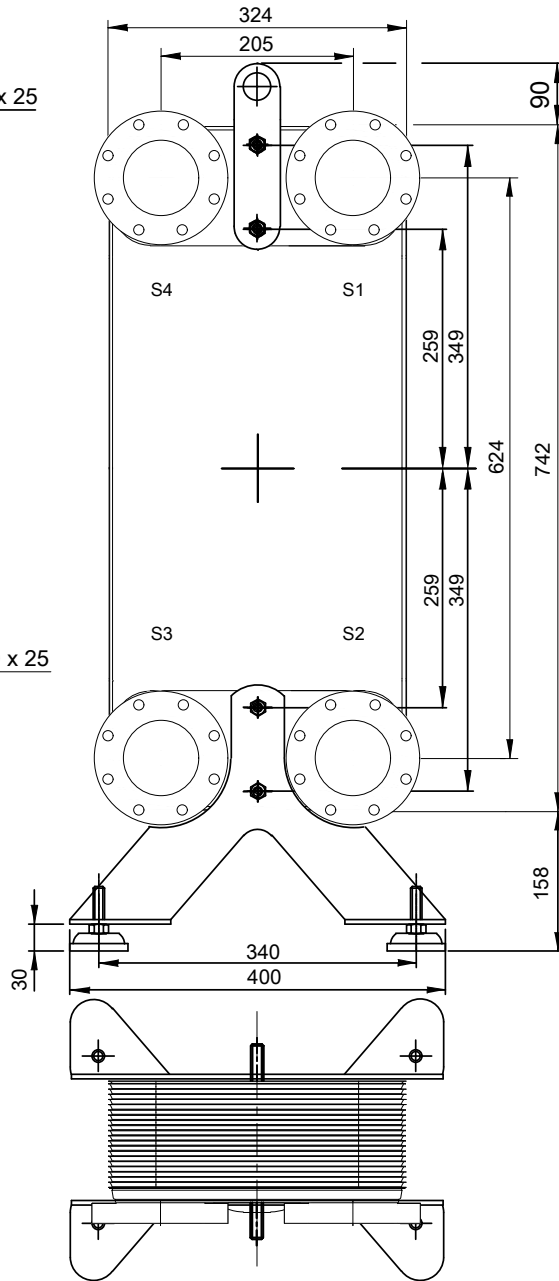

HEATING SURFACE m²
NETWEIGHT 35.9 kg
OPERATING WEIGHT kg
PLATE MATERIAL ALLOY 316
PLATE GROUPING 1*14L/1*15L

T1 T2 T3 T4 locations on back side correspond to S1 S2 S3 S4 on front side

ALL DIMENSIONS IN MILLIMETERS

SIDE	MEDIA	INLET	TEMP. °C	OUTLET	TEMP. °C	FLOW RATE	PRESSURE DROP	LIQUID VOL.
1	Water	S1	°C	S2	°C	kg/h	kPa	7.7 dm ³
2	Water	S3	°C	S4	°C	kg/h	kPa	7.1 dm ³

PRESSURE VESSEL APPROVAL

PED

CB200-30L (3287070527)

www.alfalaval.com

CUSTOMER NAME / REF. NO.

TOTAL LENGTH 252 mm
TOTAL WIDTH 324 mm
TOTAL HEIGHT 990 mm

COMPANY / REF.
Alfa Laval Nordic AB



12/1/2018
REV 0