

Note that all unique customer requirements (i.e tolerance) need to be verified thru Alfa Laval.

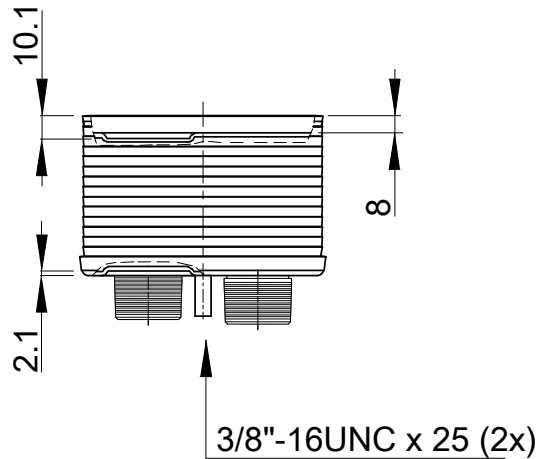
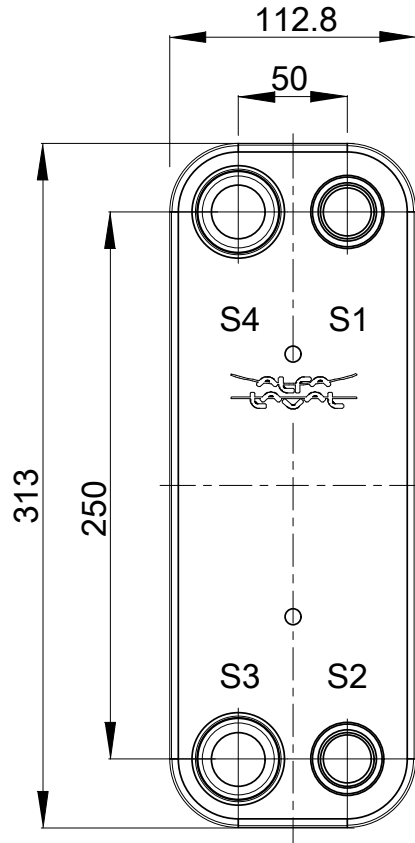
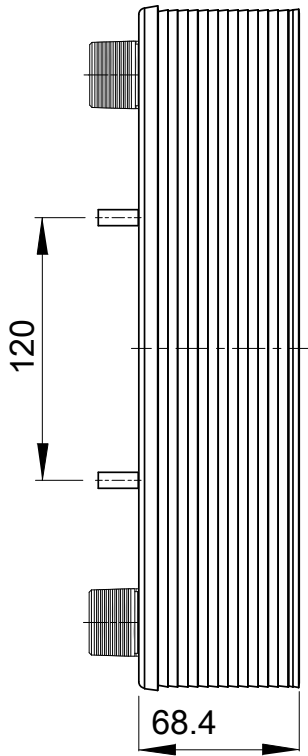
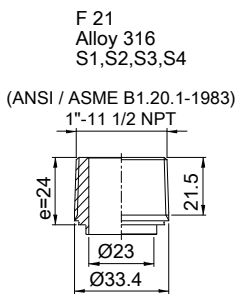

HEATING SURFACE
NETWEIGHT 4.66 kg
OPERATING WEIGHT
PLATE MATERIAL Alloy 316
PLATE GROUPING 1*11H/1*12H

T1 T2 T3 T4 locations on back side
correspond to S1 S2 S3 S4 on front side

ALL DIMENSIONS IN MILLIMETERS

SIDE	MEDIA	INLET	TEMP.	OUTLET	TEMP.	FLOW RATE	PRESSURE DROP	LIQUID VOL.
1								0.59 dm ³
2								0.65 dm ³

PRESSURE VESSEL APPROVAL

UL/CRN

CB30-24H T06 (3287099218)

www.alfalaval.com

CUSTOMER NAME / REF. NO.

TOTAL LENGTH 94.4 mm
TOTAL WIDTH 113.0 mm
TOTAL HEIGHT 313.0 mm

COMPANY / REF.

8/24/2017
REV 0