

Note that all unique customer requirements (i.e tolerance) need to be verified thru Alfa Laval.

OC01
Alloy 304
S1,S2,S3,S4

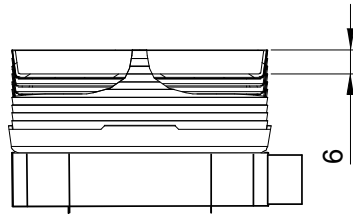
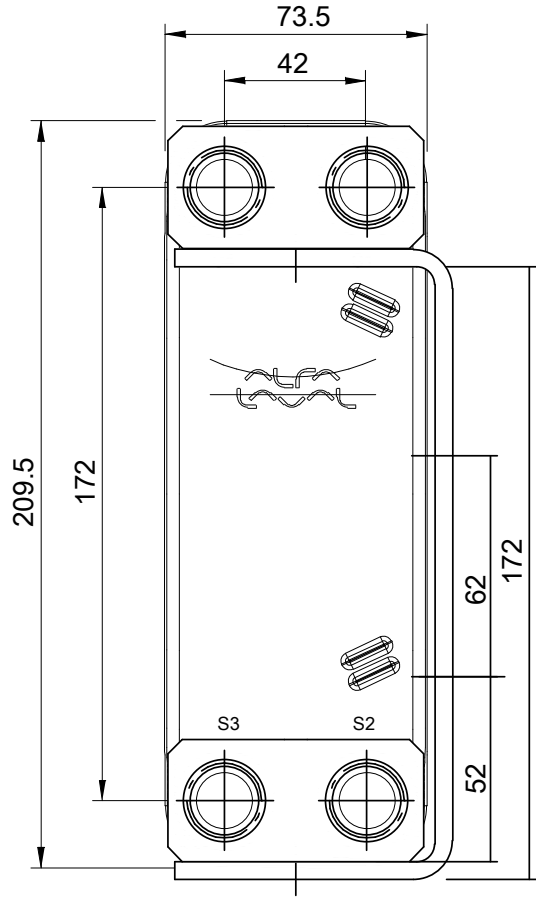
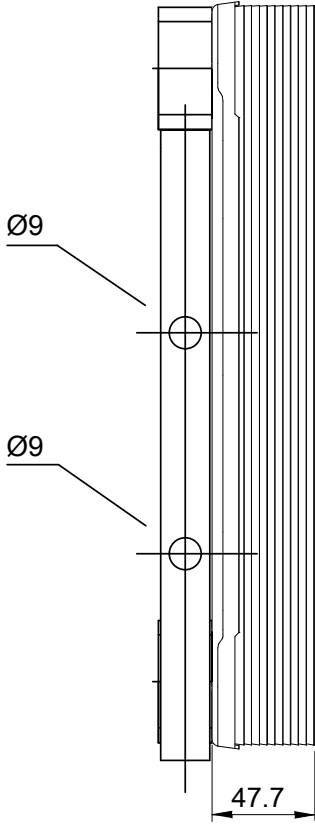
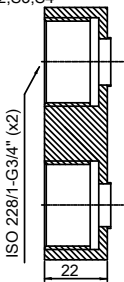

HEATING SURFACE
NETWEIGHT 1.57 kg
OPERATING WEIGHT
PLATE MATERIAL Alloy 316
PLATE GROUPING 1*8AH/1*9AL

T1 T2 T3 T4 locations on back side correspond to S1 S2 S3 S4 on front side

ALL DIMENSIONS IN MILLIMETERS

SIDE	MEDIA	INLET	TEMP.	OUTLET	TEMP.	FLOW RATE	PRESSURE DROP	LIQUID VOL.
1								0.19 dm ³
2								0.27 dm ³

PRESSURE VESSEL APPROVAL PED
DOC16-18A-F (3287119980)

www.alfalaval.com

CUSTOMER NAME / REF. NO.

COMPANY / REF.

TOTAL LENGTH 69.7 mm
TOTAL WIDTH 73.5 mm
TOTAL HEIGHT 209.5 mm

8/24/2017
REV 0