

Note that all unique customer requirements (i.e tolerance) need to be verified thru Alfa Laval.

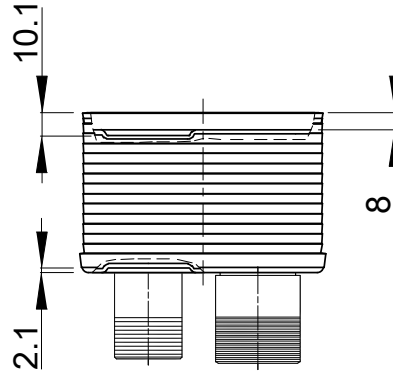
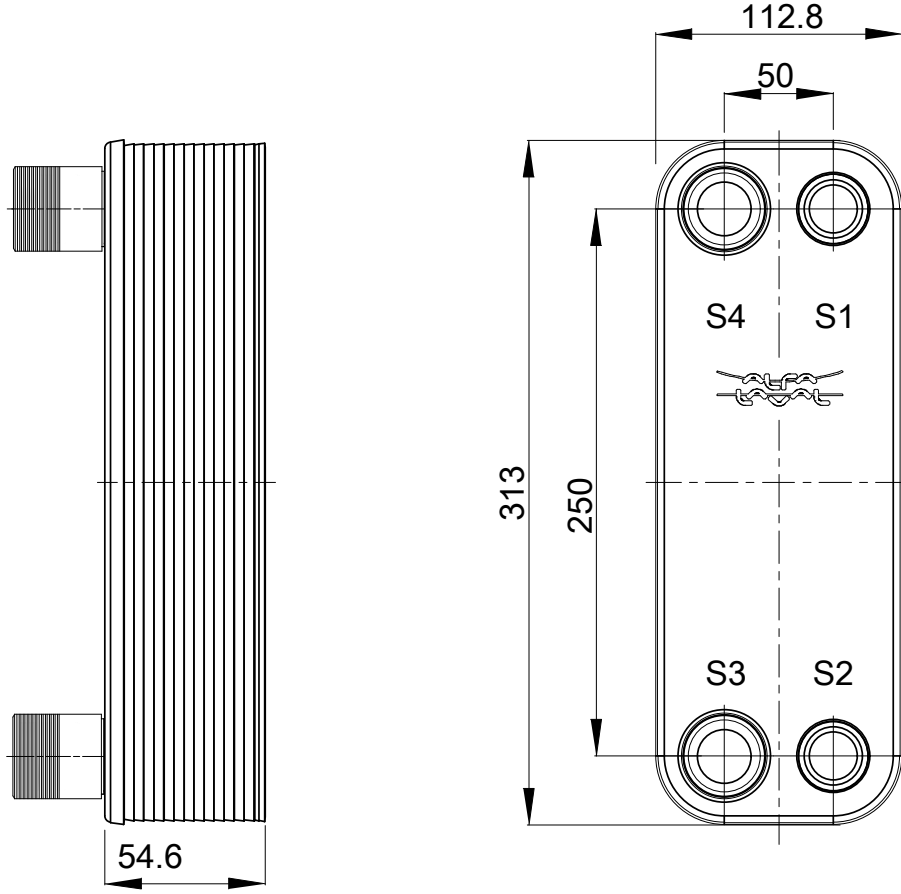
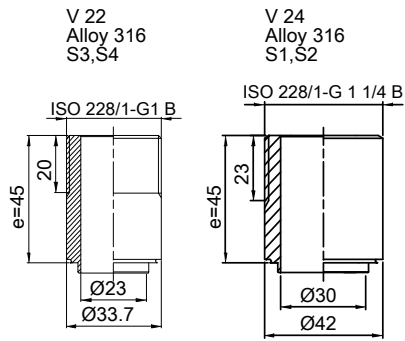

HEATING SURFACE  
NETWEIGHT 4.42 kg  
OPERATING WEIGHT  
PLATE MATERIAL Alloy 316  
PLATE GROUPING 1\*8H/1\*9H

T1 T2 T3 T4 locations on back side  
correspond to S1 S2 S3 S4 on front side

ALL DIMENSIONS IN MILLIMETERS

SIDE	MEDIA	INLET	TEMP.	OUTLET	TEMP.	FLOW RATE	PRESSURE DROP	LIQUID VOL.
1								0.43 dm <sup>3</sup>
2								0.49 dm <sup>3</sup>



PRESSURE VESSEL APPROVAL  
CB30-18H (3287083287)

PED

www.alfalaval.com

CUSTOMER NAME / REF. NO.

COMPANY / REF.

TOTAL LENGTH 99.6 mm  
TOTAL WIDTH 113.0 mm  
TOTAL HEIGHT 313.0 mm

8/24/2017  
REV 0