

Note that all unique customer requirements (i.e tolerance) need to be verified thru Alfa Laval.

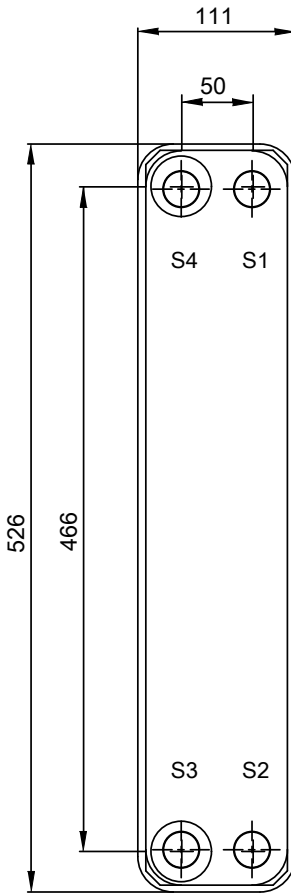
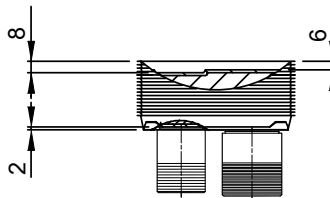
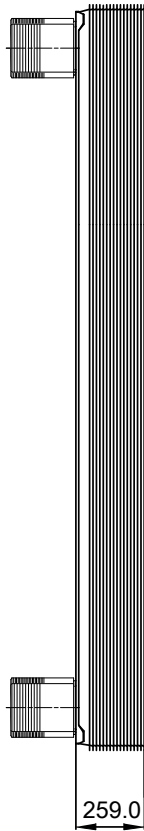
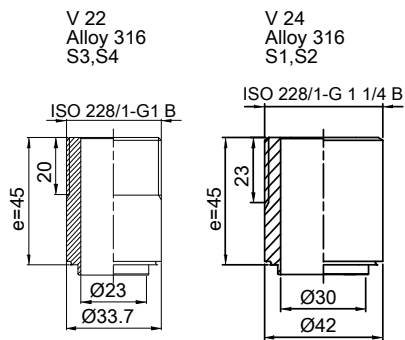

Frameplate is depressed 2 mm at connection S3/S4
 Pressureplate is depressed 2 mm / even number of channel plates
 at connections T3/T4 / uneven number of channel plates at
 connections T1/T2.

HEATING SURFACE
 NETWEIGHT 25.0 kg
 OPERATING WEIGHT
 PLATE MATERIAL Alloy 316
 PLATE GROUPING 1*49H/1*50H

T1 T2 T3 T4 locations on back side
 correspond to S1 S2 S3 S4 on front side

ALL DIMENSIONS IN MILLIMETERS

SIDE	MEDIA	INLET	TEMP.	OUTLET	TEMP.	FLOW RATE	PRESSURE DROP	LIQUID VOL.
1								4.66 dm ³
2								4.75 dm ³

PRESSURE VESSEL APPROVAL PED

AlfaNova 52-100H (3287050290)

www.alfalaval.com

CUSTOMER NAME / REF. NO.

TOTAL LENGTH 304.0 mm
 TOTAL WIDTH 111.0 mm
 TOTAL HEIGHT 526.0 mm

COMPANY / REF.



8/24/2017
 REV 0