

Note that all unique customer requirements (i.e tolerance) need to be verified thru Alfa Laval.

H 68
Alloy 304
S3

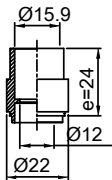

H 41
Alloy 304
S1,S2,S4

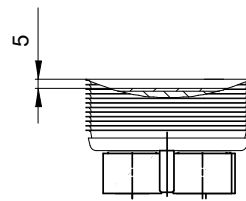
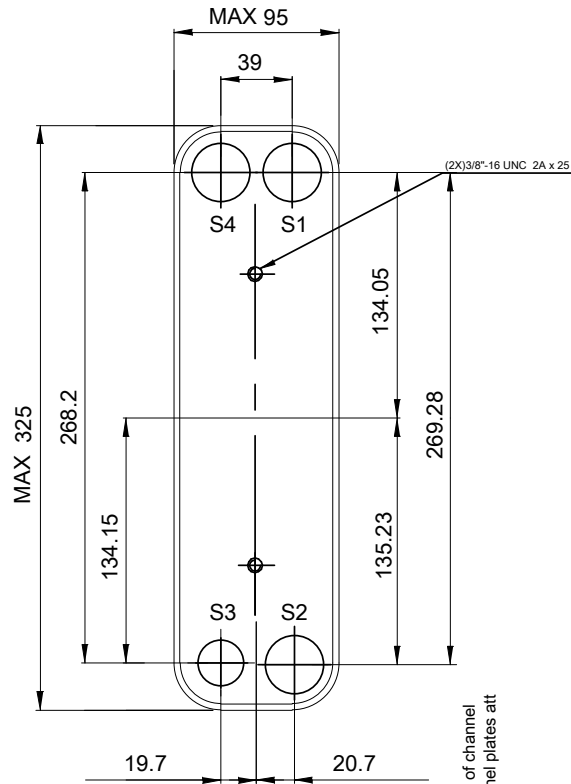
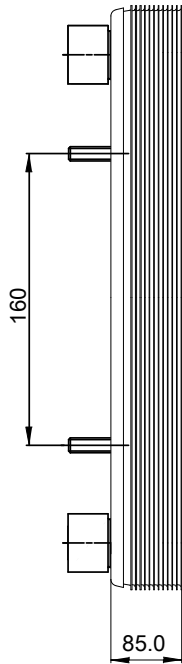
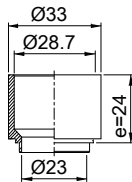

Frameplate is depressed 1.2 mm at connection S4
Pressureplate is depressed 1.2 mm / even number of channel plates at connections T4 / uneven number of channel plates at connections T1.
T1 T2 T3 T4 locations on back side correspond to S1 S2 S3 S4 on front side

HEATING SURFACE
NETWEIGHT 5.82 kg
OPERATING WEIGHT
PLATE MATERIAL Alloy 316
PLATE GROUPING 1*24H/1*25H

ALL DIMENSIONS IN MILLIMETERS

SIDE	MEDIA	INLET	TEMP.	OUTLET	TEMP.	FLOW RATE	PRESSURE DROP	LIQUID VOL.
1								0.67 dm ³
2								0.7 dm ³

PRESSURE VESSEL APPROVAL

UL/CRN

ACH-30EQ-50H S21 (3287084897)

www.alfalaval.com

CUSTOMER NAME / REF. NO.

COMPANY / REF.

TOTAL LENGTH 111.0 mm
TOTAL WIDTH 95.0 mm
TOTAL HEIGHT 325.0 mm

3/15/2017
REV 0